

UN180-6X (6V180Ah)

GENERAL FEATURES

- Absorbent Glass Mat (AGM) technology for efficient gas recombination of up to 99% and freedom from electrolyte for air transport-complies with LATA/ICAO Special provision A67.
- Not restricted for air transport-complies with LATA/ICAO Special Provision A67.
- UL-recognized component.
- Can be mounted in any orientation.
- Computer designed lead, calcium tin alloy grid for high power density.
- Long service life, float or cyclic applications,
- Maintenance-free operation.
- Low self discharge.
- Case and cover available in both standard and flame retardant ABS.

SPECIFICATION

Nominal voltage	6V	Dimensions	Total Height	8.90inches(226mm)
Rated capacity (10 hour rate)	180Ah		Height	8.66inches(220mm)
Number of cell	3		Length	12.1inches(306mm)
Approx. Weight (Kg / lbs)	26.8/59.1		Width	6.61inches(168mm)

Battery Dimensions

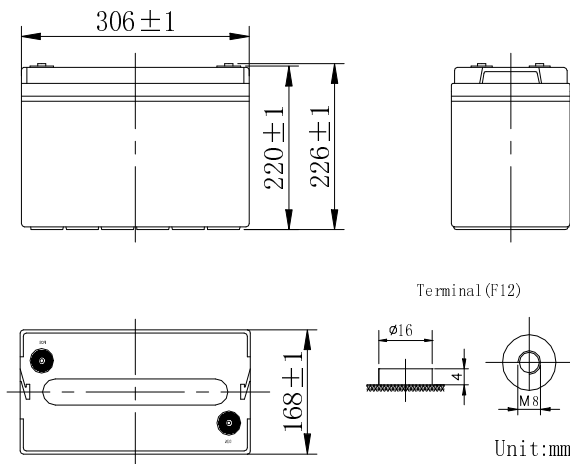

Characteristic

Capacity 77° F(25°C)	20 hour rate (9.3A、5.25V)	186Ah
	10 hour rate (18A、5.25V)	180Ah
	5 hour rate (31A、5.25V)	155Ah
	3 hour rate (46A、5.1V)	138Ah
	1 hour rate (110A、4.8V)	110Ah
	1C (180A、4.8V)	32min
Internal Resistance	Full charged Battery 77° F(25°C) : 1.8 mΩ	
Capacity affected by Temperature (20 hour rate)	104° F(40°C)	102%
	77° F(25°C)	100%
	32° F(10°C)	85%
	5° F(-15°C)	65%
Self-Discharge 68° F(20°C)	Capacity after 3 month storage	90%
	Capacity after 6 month storage	80%
	Capacity after 12 month storage	60%
Max. discharge current 77° F(25°C) : 950A(5S)		
Charge (Constant Voltage)	Float: 6.80~6.90 V/77° F(25°C)	
	Cycle: 7.25~7.45 V/77° F(25°C) Max. Current: 45A	

Constant power discharge ratings-watts per cell at 25°C(77° F)

End Point Volts/Cell	5min	10min	15min	30min	45min	1h	2h	3h	5h
1.60V	860	685	563	366	250	228	128	88.2	60.5
1.65V	825	652	543	354	245	224	124	87.2	60.2
1.70V	772	617	524	344	239	220	122	86.1	59.7
1.75V	718	584	502	333	233	215	120	85.1	59.4
1.80V	661	548	479	322	229	208	119	83.7	58.7

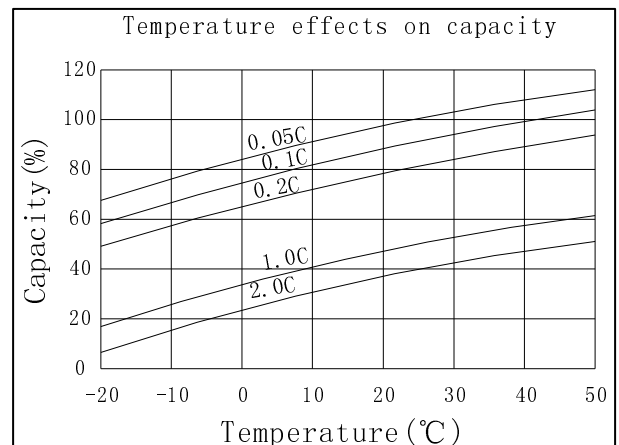
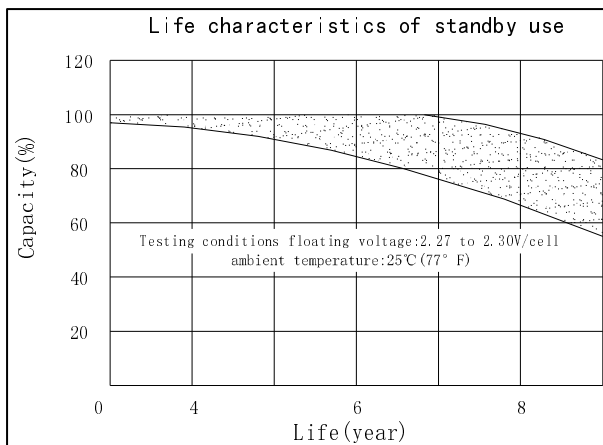
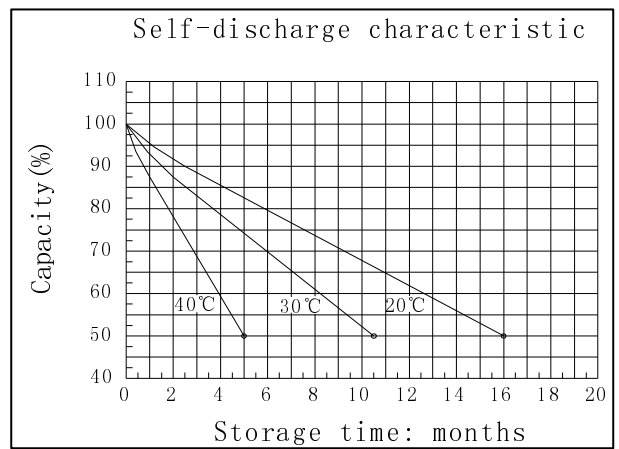
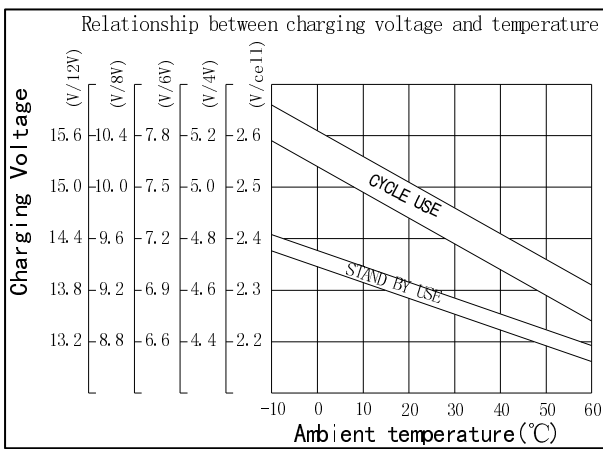
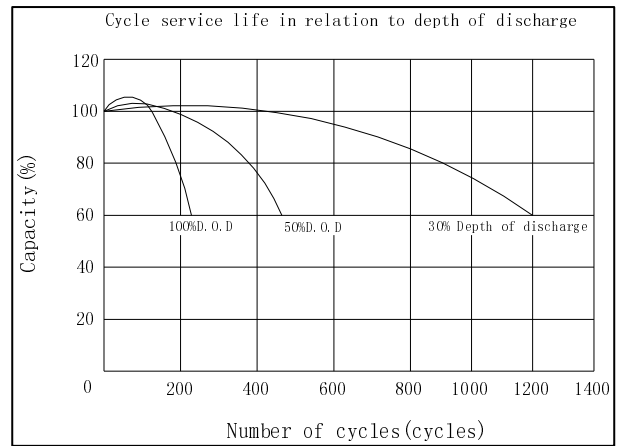
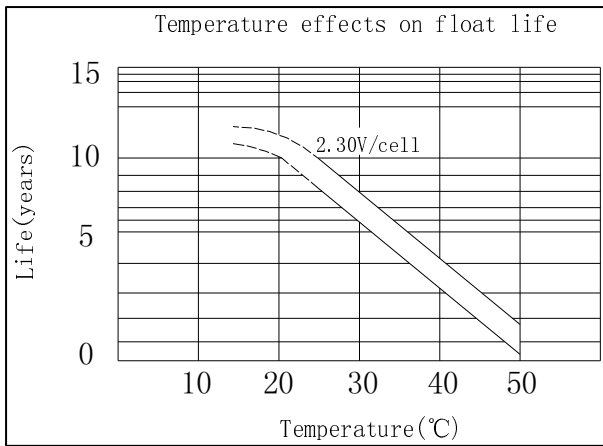
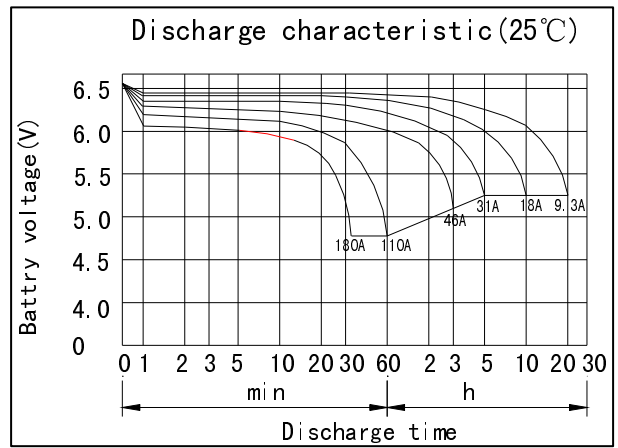
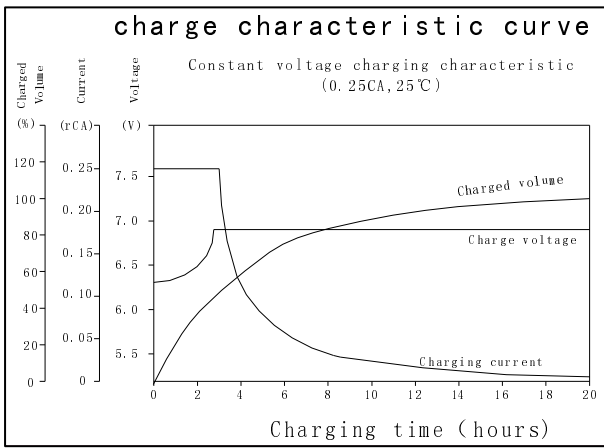

OREMA POWER CO., LTD

Add: Datang Industry Park Xinfeng Ganzhou City, Jiangxi Province, China

TEL: +86-0797-2299669 +86-0797- 2299553

FAX: +86-0797-2299553



www.oremabattery.com